

Data Sheet

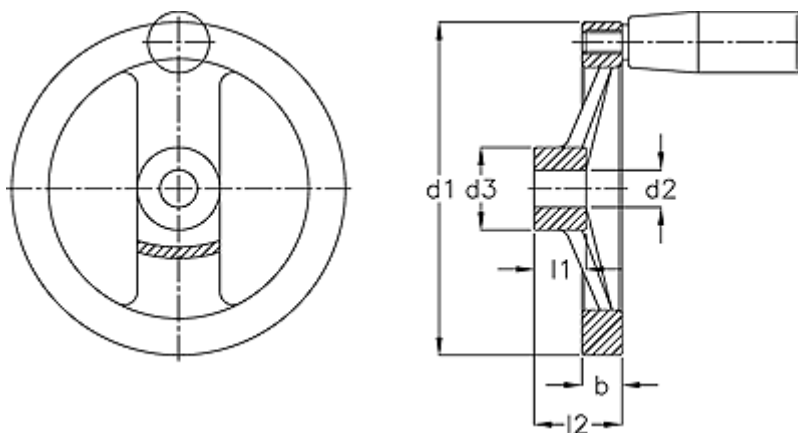

Article number: 201281332
Description: E+G Handwheel
GN 322-200-K18-R

Measures



b	=	20.5
d1	=	200
d2 H7	=	18
d3	=	42
Handle	=	25
l1	=	24
l2	=	45